

Logical Reasoning Sample Test Class-7

Total-Question:15

Time:15.0 Mins

PATTERN & MARKING SCHEME	
Section	(1) Logical Reasoning Sample Test Class-7
No. of Questions	15
Marks per Ques.	1

Logical Reasoning Sample Test Class-7

Q 1.

Four friends M, N, O and P are playing cards. If P faces towards North and M faces towards West, then who faces towards South?

- A O
- B N
- C P
- D Data inadequate

Q 2.

Pointing towards a man, Radhika said, "His sister is my daughter's brother's mother." How is the man related to Radhika?

- A Brother
- B Father
- C Uncle
- D Grandfather

Q 3.





Select the option which will replace the question mark in the given number series.
198, 194, 185, 169, ?

- A 92

- B** 112
- C** 136
- D** 144

Q 4.

Which of the following Venn diagrams represents the best relationship amongst "Men, Trees and Living beings"?

- A** 
- B** 
- C** 
- D** 

Q 5.

Which of the following numbers will complete the given figure?

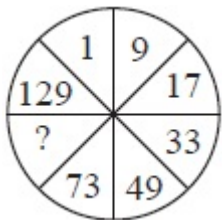

- A** 90
- B** 97
- C** 107
- D** 117

Q 6.

Select a pair of figures from the options which has same condition of placement of dots.

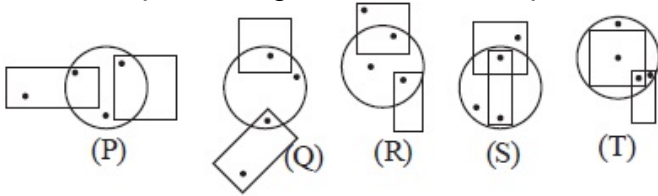

- A** P, Q
- B** Q, R
- C** R, S
- D** S, Q

Q 7.

If the digits of a watch are replaced by every alternate letter in alphabets starting from 12, in the reverse order, i.e. 12 is replaced by A, 11 is replaced by C and so on, then at which letter would be the hour hand when it is 5:00 pm?

- A** P
- B** N
- C** O
- D** Q

Q 8.

Count the number of rectangles in the given figure.

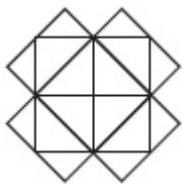

- A** 20
- B** 18
- C** 16
- D** 14

Q 9.

Find the mirror image of the given Figure (X), if the mirror is placed vertically to the left.

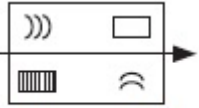
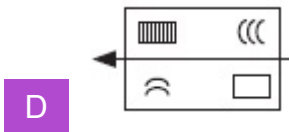
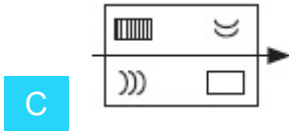
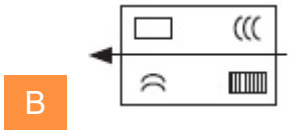

Figure (X)



Q 10.

Arrange the given units in a meaningful sequence.

1. Hecto
2. Centi
3. Deca
4. Kilo
5. Deci

A 1, 3, 4, 5, 2

B 1, 5, 3, 4, 2

C 2, 5, 3, 1, 4

D 5, 2, 1, 4, 3

Q 11.

Find the missing figure in the given pattern.



Q 12.

A cube and its net is given below. Identify the letter on the top of the cube.

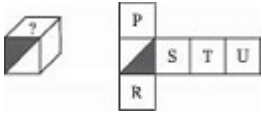

- A** S
- B** T
- C** U
- D** R

Q 13.

If Armaan is facing South-east of P after turning 135° clockwise, then he was facing at first.

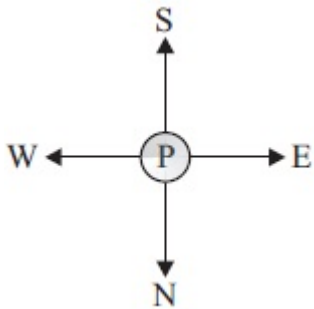

- A** North
- B** North-west
- C** West
- D** North-east

Q 14.

If the figures having some characters given below follow the same rule, then find the missing number from the options.

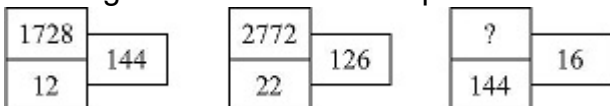

- A** 1304
- B** 2304
- C** 2034
- D** 1034

Q 15.

Arrange the given below words in the order as in a dictionary.

(i) Mercury (ii) Showroom (iii) Rice
(iv) Petrol (v) Oranges

A (i), (v), (iv), (ii), (iii)

B (i), (iv), (v), (iii), (ii)

C (i), (v), (iv), (iii), (ii)

D (ii), (iii), (iv), (v), (i)

Answers

Logical Reasoning Sample Test Class-7

1.D 2.A 3.D 4.B 5.B 6.A 7.C 8.A 9.B 10.C 11.C 12.D 13.C 14.B 15.C

Solutions:

S 1.

Answer - (D) Data inadequate

S 2.

Radhika has a daughter and a son.

The boy's mother (i.e. Radhika) is the sister of the man.

Answer - (A) Brother

S 3.

The difference between -

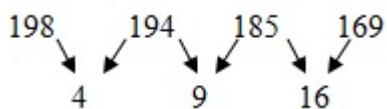

To get the next number subtract 25 from 169 = 144

Answer - (D) 144

S 4.

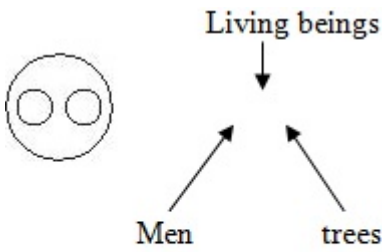

Answer-(B)

S 5.



Difference - 8 8 16 16 24 2432 → Should be

$$73 + 24 = 97$$

Answer - (B) 97

S 6.

One dot is in the rectangle only.
 Second dot is in the circle only.
 Third dot is common to circle and rectangle.
 Fourth dot is common to circle and square.
 Answer - (A) P, Q

S 7.

12 is replaced by A, 11 is replaced by C, 10 is replaced by E, 9 is replaced by G, 8 is replaced by I, 7 is replaced by K, 6 is replaced by M, 5 is replaced by O.
 Answer - (C) O

S 8.

The figure may be labelled as shown.

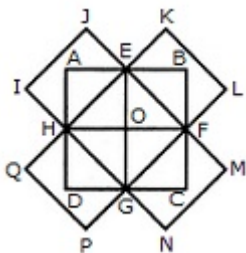

The rectangles composed of two components each are HIJE, EKJF, FMNG, GPQH, AEOH, EBFO, OFCG and HOGD i.e. 8 in number.

The rectangles composed of four components each are ABFH, BCGE, CDHF, DAEG and EFGH i.e. 5 in number.

The rectangles composed of six components each are IJFG, KLGH, MNHE and PQEF i.e. 4 in number.

The rectangles composed of eight components each are IJMN, KLPQ and ABCD i.e. 3 in number.

Thus, there are $8 + 5 + 4 + 3 = 20$ rectangles in the given figure.

(Here note that the squares are also counted amongst rectangles)

Answer - (A) 20

S 9.

The arrow will point away from the mirror.

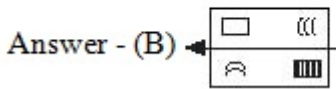
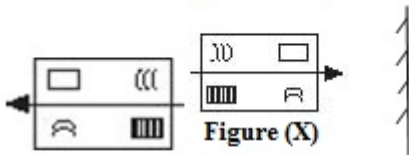

S 10.

Metric Conversion Chart

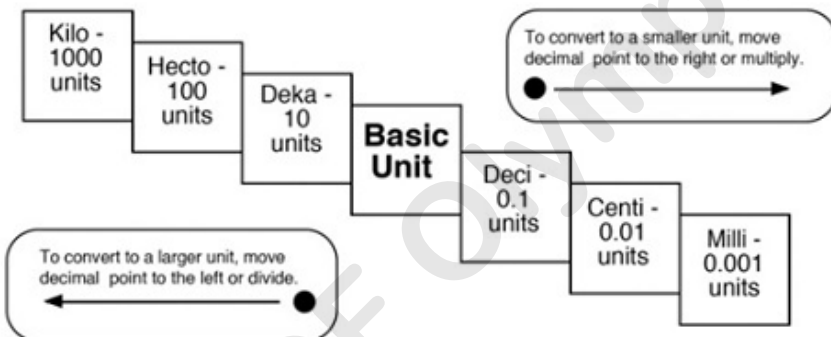

Answer - (C) 2, 5, 3, 1, 4

S 11.

The dot has moved 1 and a $\frac{1}{2}$ side in the 1st and 2nd figure. Similarly it has moved 1 and $\frac{1}{2}$ side in the 3rd and 4th.

By looking at the 6th figure the dot should be top left corner.

Answer-(C)

S 12.

By turning the net upside down it is seen that R is at the top.

Answer-(D) R

S 13.

Armaan turns 1350 clockwise to be in the position shown below.

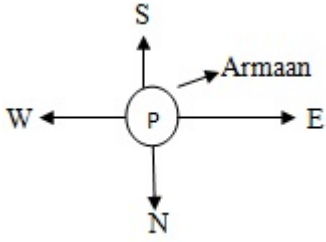

At first he was 1350 anti clockwise.

So, he was facing west.

Answer-(C) West

S 14.

$$12 \times 144 = 1728, 22 \times 126 = 2772$$

$$\text{So, } 144 \times 16 = 2304$$

Answer-(B) 2304

S 15.

(i) Mercury (v) Oranges (iv) Petrol (iii) Rice (ii) Showroom

Answer-(C) (i), (v), (iv), (iii), (ii)